

26. Benedict, R.C., E.D. Strange and C.E. Swift, *J. Agri. Food Chem.* 23(2):167 (1975).
27. Love, J.D., and A.M. Pearson, *JAOCs* 48:547 (1971).
28. Kwoh, T.L., *Ibid.* 48:550 (1971).
29. Toyoda, I., J. Terao and S. Matsushita, *Lipids* 17:84 (1982).
30. MacDonald, B., J.I. Gray and L.N. Gibbins, *J. Food Sci.* 45:893 (1980).
31. Bligh, E.G. and W.J. Dyer, *Can. J. Biochem. Physiol.* 37:911 (1959).
32. Gray, J.I., *JAOCs* 55:539 (1978).
33. Krull, I.S. and Wolff, M.H., *American Laboratory* 11 (5):84 (1979).

[Received June 21, 1983]

Continuous Synthesis of Glycerides by Lipase in a Microporous Membrane Bioreactor

MOHAMMAD MOZAMMEL HOQ, TSUNEO YAMANE*, and SHOICHI SHIMIZU, Laboratory of Bioreaction Engineering, Department of Food Science and Technology, Faculty of Agriculture, Nagoya University, Chikusa-ku, Nagoya 464, Japan and TADASHI FUNADA and SHIRO ISHIDA, Research Laboratory, Amagasaki Works, Nippon Oil and Fats Co., Ltd., Ohama-cho, Amagasaki 660, Japan

ABSTRACT

A membrane bioreactor was developed for continuous synthesis of glycerides by lipase to overcome the drawbacks associated with the usual operation in an emulsion system. One unit (total area: 726 cm²) of flat, plate-type dialyzer was used as the membrane bioreactor at 40 C. The glycerol solution, containing bacterial lipase and water, was supplied continuously to 1 side of a sheet of microporous polypropylene membrane (strongly hydrophobic) and the effluent was recycled, while undiluted liquid fatty acid (oleic or linoleic) was fed continuously to the opposite side of the membrane and came in contact with a glycerol-water-lipase solution to cause the reaction. The product, glycerides, was obtained at the outlet, in a pure state, with no other phase. Highest conversion (ca. 90%) was obtained when the water content of the glycerol solution was 3-4%. As the accumulation of water produced by the reaction lowered the conversion, molecular sieves in a column that the glycerol solution passed through were used for optimal water content. The reaction could be continued at least for 1 month, yielding a conversion above 70% when 1% CaCl₂ was added in the glycerol solution. The main component of glycerides formed was almost equimolar amounts of mono- and diglycerides.

INTRODUCTION

Glycerol and polyglycerol esters of fatty acids are industrially prepared and commercially available as food flavors, pharmaceuticals, fragrances and emulsifiers (1,2). The industrial processes are based on direct esterification of fatty acids with glycerol and polyglycerol of various chain length in the presence of inorganic catalyst at elevated temperatures (200-250 C). The chemical reaction is tedious, nonselective and consumes a large amount of energy. Furthermore, the product obtained usually needs further purification through a bleaching process (3).

In recent years, the synthesis of glycerides by lipase or cell-bound enzymes has received keen attention (4-6). The enzymatic process has certain advantages over the chemical process because the former involves mild reaction conditions and stereo and positional specificities, saves energy and has enormous catalytic activity. Because lipase is soluble in an aqueous glycerol solution, but not in higher fatty acid, enzymatic synthesis of glycerides has been carried out in an emulsion system where the reaction takes place at the

interface of oil droplets and aqueous glycerol solution.

Such a conventional emulsion system for the industrial synthesis of glycerides (and for the hydrolysis of fat as well) has, however, certain drawbacks. First the emulsification of oil needs surfactant and a large power input, e.g., stirring at high speed. Second, after the reaction has finished, the separation of emulsified oily products is complicated and needs powerful centrifugation. Third, the reaction system of free lipase plus emulsified substrate is economically difficult to operate continuously. Fresh lipase must be continuously supplied to the bioreactor because the lipase adsorbed on the surface of the emulsified oil droplets is lost from the bioreactor with the droplets of products. Fourth, the immobilization of lipase involves restricted diffusion of substrate and product. One can easily imagine that particulate droplets have limited access to the enzyme, resulting in a very low reaction rate. The activity of immobilized lipase is commonly only several percent of the original activity of the free lipase. Last, control of the water content of the reaction system is difficult. The result is very important because the catalytic action of lipase is reversible. Lower water content favors the synthetic reaction, whereas, at a higher water content, hydrolysis prevails.

These limitations present obstacles to the application of lipase as a successful industrial biocatalyst in glyceride synthesis. In view of the above disadvantages of the emulsion system, an attempt has been made to carry out the continuous synthesis of glycerides from glycerol and liquid fatty acids by a lipase in a nonemulsion system. A special bioreactor, with a hydrophobic microporous membrane, has been developed for the purpose. In the present article, the configuration of the bioreactor, optimal conditions of operation and the operational stability of the lipase are described for the continuous synthesis of fatty acid glycerides.

CONFIGURATION OF THE BIOREACTOR

One unit of a plate-type dialyzer, made of plastic material (Hospal Hemodialyzer RP-6), was used as the microporous membrane bioreactor. The setup of the bioreactor is shown in Figure 1. A frame was covered with membranes (the size of 1 sheet of membrane was 11.6 cm × 31.3 cm), making a narrow compartment. The membrane is made of

*To whom correspondence should be addressed.

GLYCERIDES SYNTHESIS BY LIPASE IN BIOREACTOR

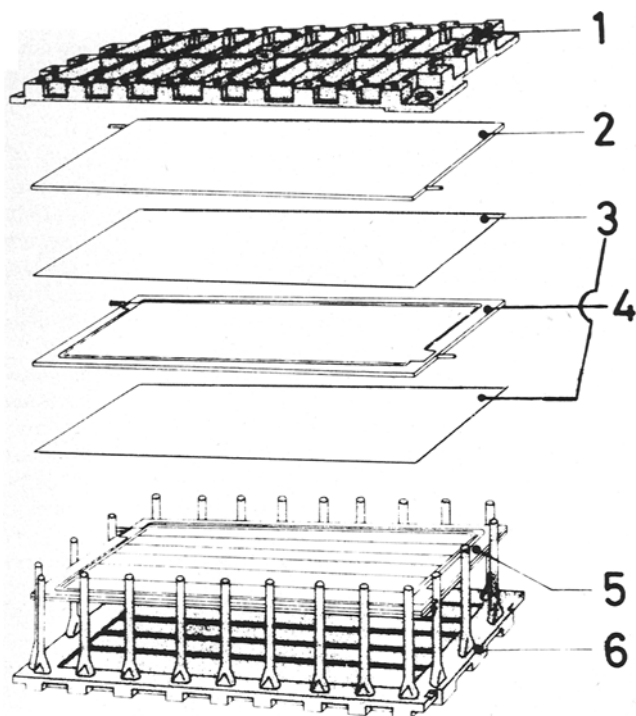

FIG. 1. The setup of the microporous membrane bioreactor: 1, upper support; 2, upper plate; 3, microporous membrane; 4, frame; 5, lower plate; 6, lower support.

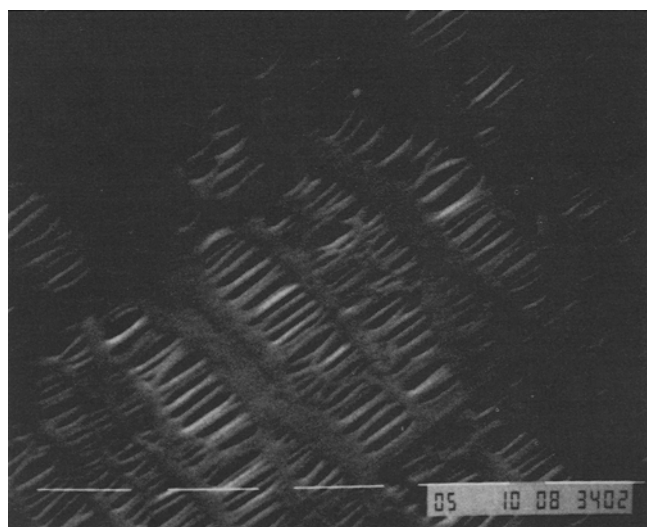

FIG. 2. Scanning electron microscopic photograph of the microporous polypropylene membrane. The length of each white straight line is equivalent to $0.5 \mu\text{m}$.

polypropylene film that has numerous micropores (porosity = 45%, maximum pore $0.04 \times 0.4 \mu\text{m}^2$, $25 \mu\text{m}$ thick; JURAGARD 2500, Polyplastics Co., Ltd., Tokyo). It is strongly hydrophobic. Figure 2 shows a scanning electron microscopic photograph of the membrane. Two plates were put on the opposite sides of the membranes (the upper and lower plates). The membrane surfaces of the plates were grooved (0.5 mm deep and 0.8 mm wide bifurcated grooves, the total number of grooves was 115). The plates and frame, together with the membranes, were placed between upper and lower supports and fastened firmly by 24 bolts

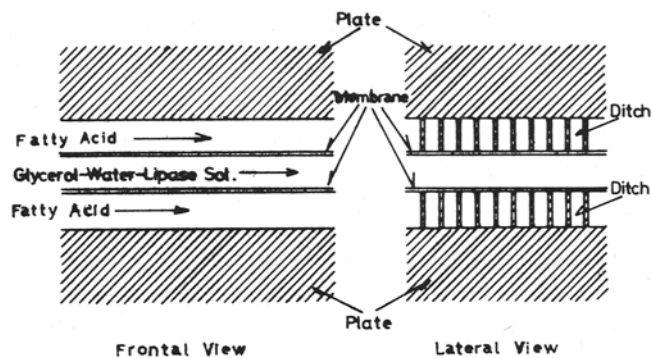

FIG. 3. Flows of fatty acid and glycerol-water-lipase solution in the bioreactor.

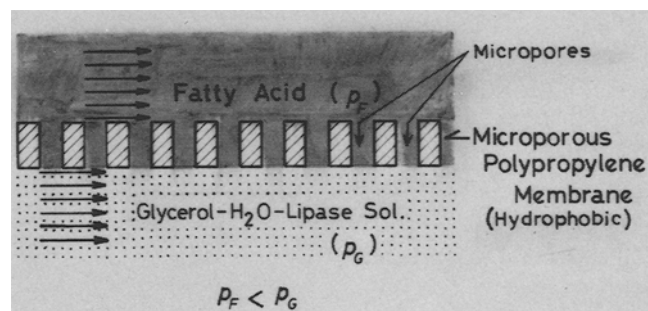

FIG. 4. The neighborhood of the membrane. Micropores are drawn very schematically.

and nuts using a torque wrench ($14 \text{ kgf}\cdot\text{cm}^2$). Thus, the reactor system resulted in a closed chamber, leaving no room to hold air when it was filled with reactants. The glycerol-water-lipase solution passed through the compartment between the 2 sheets of the membranes. Fatty acid was passed on the other sides of the compartment in the grooves of the plates. The holdups of fatty acid and glycerol solution were ca. 15 mL and 13 mL . The flow of the substrates can be seen in Figure 3. In the lateral view of the reactor, the grooves are illustrated. Because of the hydrophobic nature of the membrane, fatty acid penetrated easily through the micropores of the membrane, while glycerol-water-lipase solution could not. However, because of the high viscosity of the glycerol-water-lipase solution, the pressure of the solution, P_G , was a little greater than that of the fatty acid, P_F , which did not allow the fatty acid to pass through the membrane ($P_G = 0.25 \text{ atm}$ and $P_F = 0 \text{ atm}$, in gages). Thus, the fatty acid came in contact with glycerol-water-lipase solution as shown in Figure 4. The reaction took place at the interface of the membrane and glycerol-water-lipase solution phase. The main product, glycerides, diffuses back into the bulk flow of the fatty acid phase while the other product, water, diffuses into the bulk flow of the glycerol-water-lipase solution.

A process-flow diagram of the reaction system is shown in Figure 5. The fatty acid was fed into the reactor with a reciprocal (plunger) pump (Micro pump, Model SP-100, Sibata Chemical Apparatus Manufacturing Co., Ltd., Tokyo) and the product formed, glycerides, was obtained from the outlet in a pure state with no other phase. That is, the glycerides obtained were never mixed with glycerol solution. The glycerol-water-lipase solution was fed into the membrane bioreactor with a peristaltic pump (minipuls 2, Gilson France SA, Villiers Le Bel, France). The solution from the outlet passed into the controlled dehydration system and reentered the reactor. Thus, the solution was

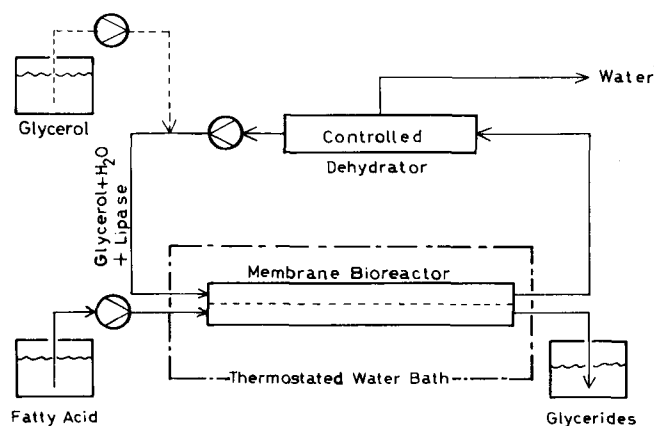

FIG. 5. Process-flow diagram of the reaction system. Glycerol was replenished only during the long-term continuous experiments.

recycled. In the short-term experiments, no glycerol was supplemented, but in the long-term experiments, glycerol was supplied at an appropriate feed rate. The membrane bioreactor was placed in a constant-temperature water bath (40 C).

EXPERIMENTAL PROCEDURE

Materials

Lipase from *Chromobacterium viscosum* var. *paralipolyticum* (7-11), produced by Toyo Jozo Co., Ltd., Tokyo, was used throughout the experiments. Its hydrolytic activity, determined by the olive-oil emulsion method described previously (12), was ca. 30 unit/mg. One unit of activity is defined as the amount of the enzyme that liberates 1 μmol equivalent of fatty acid from olive oil in 1 minute under the analytical condition. The lipase has weak positional specificities for α -position. Two kinds of oleic acids were used: Extra Olein 90 (composition: 92.0% oleic acid, 2.4% palmitic acid, 2.0% stearic acid, 1.2% linoleic acid, 1.8% other acids and 0.6% unknown compound) and Extra Olein 99 (the content of oleic acid was over 99.9%). The composition of linoleic acid used was: 99.3% linoleic and 0.1% oleic acid, 0.4% linoleic acid and 0.2% of unknown compound. Extra olein 90, Extra Olein 99 and linoleic acid were produced by Nippon Oil and Fats Co., Ltd., Tokyo, Japan. The glycerol we used was of reagent grade.

Start-up of Continuous Experiments

Glycerol solution, having a required water content, was prepared in a beaker and a definite amount of lipase was dissolved in it. The beaker was put in a desiccator containing silica gel to prevent moisture absorption. The glycerol solution was fed into the bioreactor with the help of a peristaltic pump. After the reactor was filled up with the glycerol solution, the fatty acid feeding was started. When the fatty acid came out of the outlets, the reactor was dipped into a constant-temperature water bath (40 C). Initially, both fatty acid and glycerol solution were fed at higher flow rates to fill them up rapidly in the reactor to save time. After being dipped in the thermostated water bath, the flow rates were adjusted. The recycle flow rate of glycerol-water-enzyme solution was ca. $10 \text{ mL}\cdot\text{h}^{-1}$ and it was kept constant throughout the experiments. The flow rate of fatty acid was adjusted at a definite value and kept constant at each run of experiment. As the reaction proceeded, water content of the glycerol solution increased.

Therefore, the glycerol-water-enzyme solution was passed through the controlled dehydration system to keep the water content at optimum level.

Method of Controlled Dehydration

We found that water content was an important factor in determining the conversion of glyceride. Since water is produced during the glyceride synthesis, water content must be controlled by dehydration. The rate of water formed through the conversion of fatty acid into triglyceride can be calculated from stoichiometry of the reaction $-0.180 \text{ g water h}^{-1}$ and $0.114 \text{ g water h}^{-1}$ at 3.2 mLh^{-1} and 2.0 mLh^{-1} of feed rate of oleic acid.

Several methods were tried as the controlled dehydration system. Two proved to be suitable. As a continuous dehydrator, we used a molecular sieves (bead type, 2-3 mm diameter, type 5A-50, Union Showa Co., Ltd., Yokkaichi City, Mie-Ken, Japan) column through which the glycerol solution was passed. The column had a 20 mm inside diameter. The rate of dehydration of the molecular sieves beads was obtained by passing glycerol solution with several percent water through the column. We found $0.0070 \text{ g water}\cdot(\text{g molecular sieves})^{-1}\cdot\text{h}^{-1}$. The amount of molecular sieves beads necessary to keep the water content of the glycerol-water-lipase solution was estimated from the rate of water formation described above and the rate of dehydration of the molecular sieves beads.

Alternatively, a vacuum dehydrator (a vacuum pump reduced the pressure to ca. 5 mm Hg inside the desiccator in which the glycerol-water-lipase solution reservoir was placed) was used for intermittent dehydration in some early, short-term experiments.

Analytical Procedure

The extent of conversion of fatty acid to glycerides was calculated by the following equation through the measurement of acid values (13);

$$\text{Conversion (\%)} = \frac{(\text{AV})_{\text{in}} - (\text{AV})_{\text{out}}}{(\text{AV})_{\text{in}}} \times 100$$

where $(\text{AV})_{\text{in}}$ is the acid value of the fatty acid supplied into the bioreactor. $(\text{AV})_{\text{in}}$ was 196.1 for Extra Olein-90, 198.6 for Extra Olein-99 and 199.3 for the linoleic acid. $(\text{AV})_{\text{out}}$ is the acid value of the product obtained from the outlet of the bioreactor.

Water content of the glycerol-water-enzyme solution (or glycerol concentration) was monitored through the measurement of the refractive index by Abbe's refractometer (Type 3, ATAGO Co., Ltd., Tokyo, Japan) at a controlled temperature (38.5 C). The calibration curve was made with a glycerol-water-enzyme solution.

The composition of the glycerides obtained as product was analyzed quantitatively by gas chromatography (GC) after silylation. The condition of the gas chromatograph was as follows: Column $25 \text{ mm}\phi \times 300 \text{ mm}$; column packing, Chromosorb W coated with 2% OV-1, column temperature, 110-320 C (increased at the rate of 7.5 C per min); carrier gas, He, flow rate 50 mL/min; detector, flame ionization detector (FID). The details of the quantitative analysis of glycerides by GC will be published elsewhere.

RESULTS AND DISCUSSION

Effectiveness of Water Content Control

The water accumulated in the recycled system, if not removed, will affect the reaction rate and, hence, conversion. To determine the effect of water accumulation on conversion in this reaction system, 2 experiments were

GLYCERIDES SYNTHESIS BY LIPASE IN BIOREACTOR

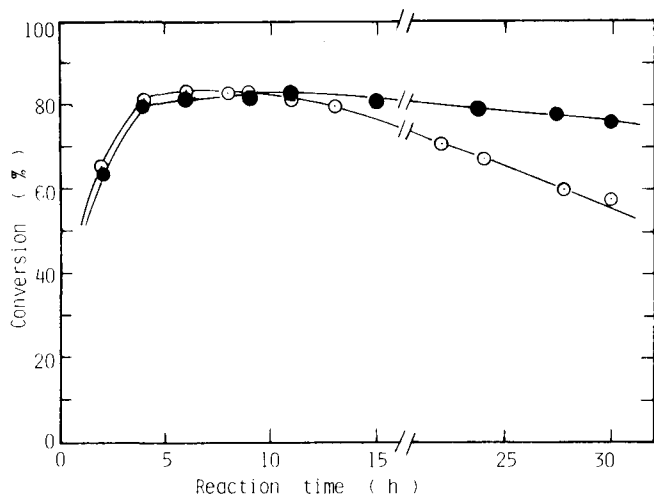

FIG. 6. Effectiveness of water-content control (the fatty acid fed was oleic acid). The figure also shows the time course of the conversion during short-term, continuous experiments. The flow rate of oleic acid (92% purity) was $3.2 \text{ mL}\cdot\text{h}^{-1}$. The enzyme concentration was $20 \text{ mg}\cdot(\text{mL glycerol-water solution})^{-1}$. —○—, no elimination of water formed; —●—, water content was controlled in the range of 7-9%.

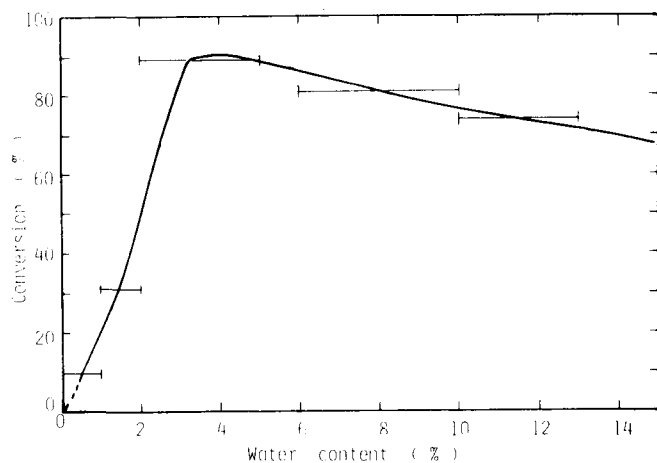

FIG. 7. Effect of water concentration on the conversion of oleic acid to glycerides. The line (—) indicates the range of water-content control. The flow rate of oleic acid (92% purity) was $3.2 \text{ mL}\cdot\text{h}^{-1}$. The enzyme concentration was $20 \text{ mg}\cdot(\text{mL glycerol-water solution})^{-1}$.

carried out, with and the other without the control of water content. The results are shown in Figure 6. When the glycerol-water-enzyme solution was recycled without any control of water content, the conversion decreased gradually. On the other hand, when water content was controlled within the range of 7-9% in the reaction mixture, a high conversion was maintained for over 15 hr. From these results, we understood that the control of water content was essential to maintain the maximum conversion at a constant level for a prolonged time. According to Figure 6, ca. 5 hr were needed to reach a steady state and the steady state lasted for more than 20 hr without any supplements of fresh glycerol if the water content was controlled.

Effect of Water Concentration on Conversion

The effect of the water content on conversion was investigated by keeping the water concentration of the glycerol solution in the ranges indicated in Figure 7. We found that

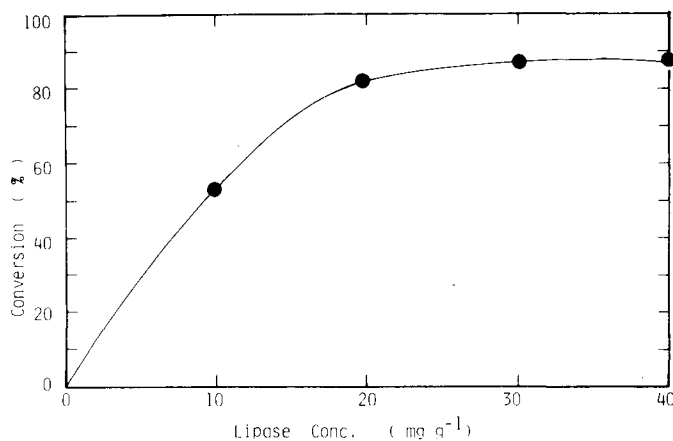

FIG. 8. Effect of initial concentration of lipase in glycerol-water solution on the conversion of oleic acid to glycerides. The flow rate of oleic acid (92% purity) was $3.2 \text{ mL}\cdot\text{h}^{-1}$. The initial water concentration was 3-4%.

the conversion was highly restricted in lower water contents, probably because some amount of water was required for the enzyme lipase to exhibit its synthetic activity. On the contrary, at higher water contents the conversion decreased because the hydrolysis reaction, the backward reaction of glyceride synthesis, becomes significant. In between, optimum water content was where the conversion was the highest. Three to four percent of the water, therefore, needed to be added to the glycerol initially under the operational conditions (flow rate of glycerol solution and enzyme concentration, and so forth). The results obtained in the present study were quite a contrast to the results of the emulsion system reported earlier. That is, in an earlier report by Tsujisaka et al., (4), the degree of synthesis (conversion) was highest at ca. 20% of water content. In their experiments, the reaction mixture was stirred at 30 C for 16 hr. At higher glycerol concentrations, stirring might not be enough to form the fine emulsion necessary for higher conversion because of the high viscosity of the glycerol solution.

Effect of Enzyme Concentration on Conversion

Figure 8 shows the effect of initial concentration of lipase in the glycerol-water solution on the conversion under the operational conditions given in the figure caption. At lower enzyme concentrations, conversion was almost proportional to the enzyme concentration, but at higher concentrations the dependence became a plateau. The plateau phenomenon of conversion at the higher initial concentrations of enzyme would be caused by a saturation of enzyme adsorbed on the interface. Diffusion of substrate or product through the oil phase or glycerol-solution phase, however, cannot be excluded.

Effect of Flow Rate of Fatty Acid on Conversion

The effect of the flow rate of oleic acid on conversion was investigated at the 2 levels of water content. The results are shown in Figure 9. The conversion decreased with the increase in the flow rates because of shorter residence times of fatty acid in the bioreactor. At lower flow rates, the conversion approached its maximum, which would be close to the true chemical equilibrium predicted from the water content of glycerol solution. To increase the conversion, the reaction will have to be carried out with a smaller water content and at lower flow rates.

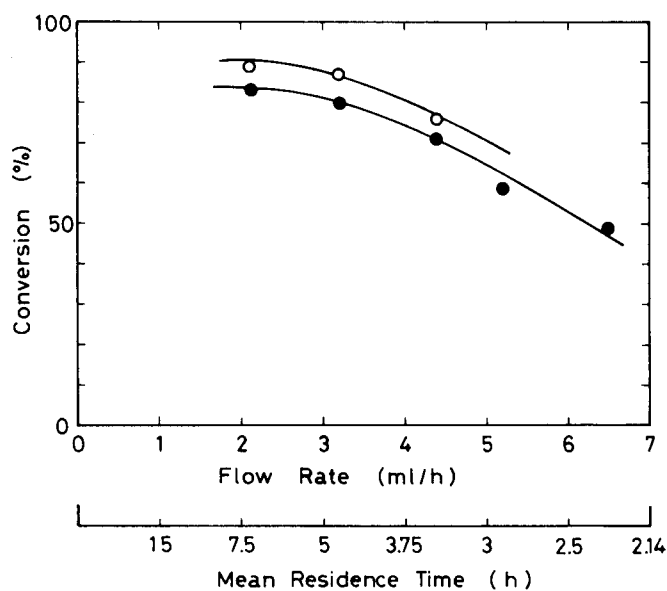

FIG. 9. Effect of flow rate of oleic acid (92% purity) on conversion. The enzyme concentration was $20 \text{ mg} \cdot (\text{mL glycerol-water solution})^{-1}$. —●—, 5-10% of water content; —○—, 3-5% of water content.

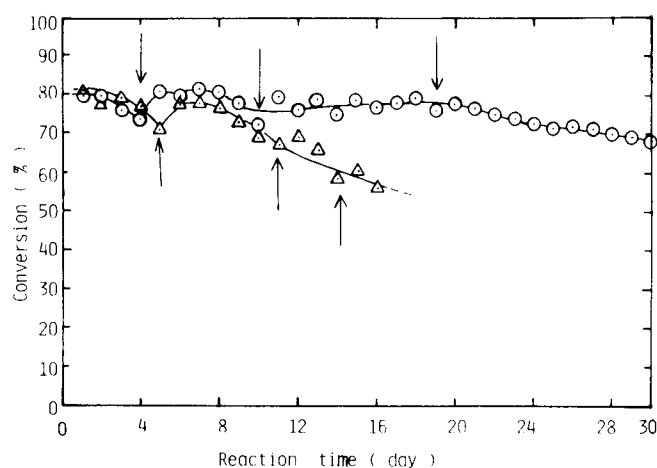

FIG. 10. Time courses of the conversion during the long-term continuous operations. The flow rate of oleic acid (92% purity) was $2.1 \text{ mL} \cdot \text{h}^{-1}$. The enzyme concentration was $20 \text{ mg} \cdot (\text{mL glycerol-water solution})^{-1}$. The arrows indicate the times of replacement of new molecular sieves column. —△—, without CaCl_2 ; —○—, with 1% CaCl_2 in the glycerol-water enzyme solution. Water content was kept 3-5% in the solution.

Operational Stability of Lipase

The long-term, continuous reaction using oleic acid of 92% purity was carried out with or without 1% CaCl_2 in the glycerol-water-enzyme solution. For controlled dehydration, the glycerol-water-lipase solution was passed through the molecular sieves column throughout the experiment. Because of the loss of the dehydration ability of molecular sieves, the column was exchanged for a new one at the times indicated in Figure 10. The amount of glycerol reacted under the experimental conditions was ca. 3.67 g/d as estimated by the difference of mass flow rates at the inlet and outlet of oil phases. The glycerol was replenished intermittently everyday as shown in Figure 5. Ca^{2+} was effective in avoiding inactivation of the lipase (Figure 10). The half-life of the enzyme was 52 days in the

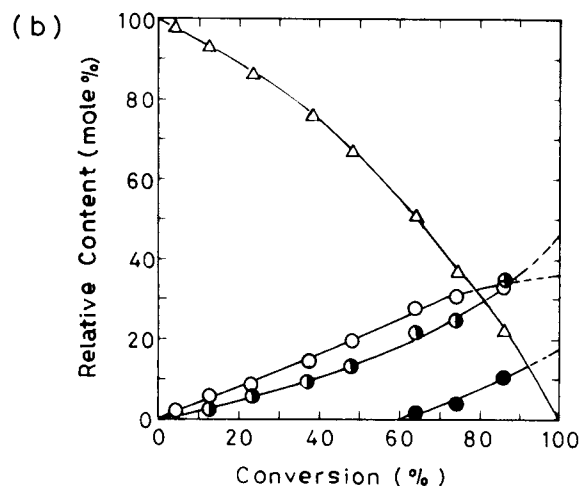
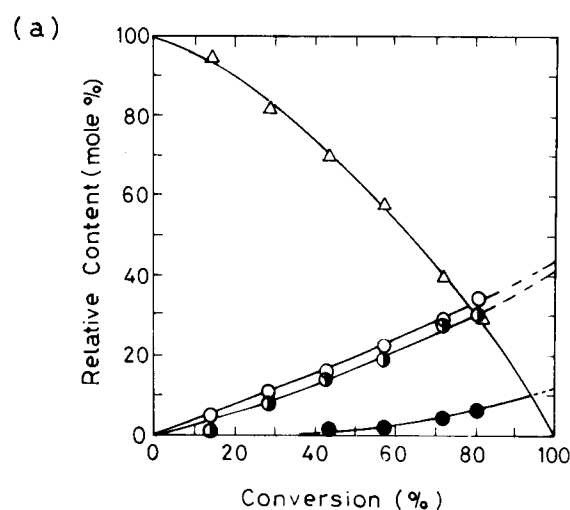

FIG. 11. Composition of glycerides produced. (a) Oleic acid (99.9% purity) was supplied at the flow rate of $2.1 \text{ mL} \cdot \text{h}^{-1}$. (b) Linoleic acid (99.3% purity) was supplied at the flow rate of $2.1 \text{ mL} \cdot \text{h}^{-1}$. In both figures, the enzyme concentration was $20 \text{ mg} \cdot (\text{mL glycerol-water})^{-1}$, and the initial water concentration was 3-4%. In both figures, —△—, free fatty acid; —○—, mono-glyceride; —□—, di-glyceride; —●—, tri-glyceride.

presence of calcium ion and 21 days in the absence of calcium ion as estimated by extrapolating the time courses of the conversion. The prolonged high activity of the enzyme may be caused by the combination of both the protecting effect of high glycerol concentration and the stabilizing effect of calcium ion. Polyhydric alcohols, e.g., glycerol protect the enzymes from their denaturation (14) and some lipases are stabilized or even activated by calcium ion (15).

Composition of Glycerides

To know the composition of glycerides having various acid values, 7 mL each of output was collected, from the start of the continuous operations, with a fraction collector and was analyzed by GC. The results of the analysis of oleic acid (99.9%) and linoleic acid glycerides are shown in the Figure 11 (a) and (b). The results indicate that almost equimolar mono- and diglycerides were produced even when the conversion was more than 80% and that the quantities of triglycerides were negligible or very small. This phenomenon may be in accord with the fact that the used lipase has a weak specificity of hydrolysis toward α -position

(1-C and 3-C). Tsujisaka et al. found that a lipase that cannot hydrolyze the ester bond at β -position (C_2) hardly synthesizes ester bond at the same position, yielding mainly 1-monoglyceride and 1,3-diglyceride (4).

General Discussion

A new bioreactor with a hydrophobic microporous membrane was developed for continuous synthesis of glycerides by lipase in a nonemulsion system. The advantages of the new microporous membrane bioreactor are summarized as follows. First, the bioreactor does not require the making of an emulsion. This obviates the need for surfactant and stirring. Second, the oily product can be obtained in a pure state with no other phase. Third, the control of the water content is easier in this nonemulsion system than in the conventional emulsion system. Fourth, autoxidation of fatty acid is avoidable in the bioreactor simply by freeing the fed substrate from oxygen because the bioreactor has no free space to hold air inside when it is filled with reactants. Last, the flow of the fatty acid in this microporous membrane bioreactor is close to plug flow, whereas the emulsion system is always operated in perfect mixing. These advantages might be exploited to push forward to industrial application. Unit sets of the bioreactor could be piled up to make a bigger set, resulting in a large surface area in a compact system. Alternatively, one might be able to use hollow fiber modules as a more effective bioreactor configuration.

ACKNOWLEDGMENT

This work was supported in part by a Grant-in-Aid for Scientific Research from the Ministry of Education, Science and Culture of Japan (Project Number 57550601).

REFERENCES

1. Babayan, V.K., and R.T. McIntyre, *JAOCS* 48:307 (1971).
2. Babayan, V.K., T.G. Kaufman, H. Lehman and R.J. Thaczek, *J. Soc. Cosmet. Chem.* 15:473 (1964).
3. Kaufman, V.R., and N. Garti, *JAOCS* 59:471 (1978).
4. Tsujisaka, Y., S. Okumura and M. Iwai, *Biochim. Biophys. Acta* 489:415 (1977).
5. Bell, G., J.A. Blain, J.D.E. Patterson, C.E.L. Shaw and R. Todd, *FEMS Microbiology Letters* 3:233 (1978).
6. Seo, S.W., Y. Yamada and H. Okada, *Agric. Biol. Chem.* 46:405 (1982).
7. Yamaguchi, T., N. Muroya, M. Isobe and M. Sugira, *Ibid.* 37:999 (1973).
8. Sugira, M., M. Isobe, N. Muroya and T. Yamaguchi, *Ibid.* 38:974 (1974).
9. Sugira, M. and M. Isobe, *Biochim. Biophys. Acta* 341:195 (1974).
10. Sugira, M. and M. Isobe, *Chem. Pharm. Bull.* 23:1226 (1975).
11. Horiuchi, Y., H. Koga and S. Gocho, *J. Biochem.* 80:367 (1976).
12. Yamané, T., T. Funada and S. Ishida, *J. Ferment. Technol.* 60:517 (1982).
13. Paquot, C., *Standard Methods for the Analysis of Oils, Fats and Derivatives*, 6th Ed., New York, Pergamon Press, 1979, p. 52.
14. Butter, L.G., *Enzyme Microb. Technol.* 1:253 (1979).
15. Brocherhoff, H. and Jensen, R.G., *Lypolytic Enzymes*, New York, Academic Press, 1974, p. 106.

[Received August 3, 1983]

❁ Prooxidant Activities of Chlorophylls and Their Decomposition Products on the Photooxidation of Methyl Linoleate

Y. ENDO, R. USUKI and T. KANEDA, Department of Food Chemistry, Faculty of Agriculture, Tohoku University, Sendai, Japan, 980

ABSTRACT

Although chlorophylls in oils affect oxidative stabilities, little has been known about the prooxidant activity of the chlorophylls or their decomposition products. To evaluate the prooxidant activities of chlorophyll derivatives, chlorophyll (CHL) A and B, pheophytin (PHY) A and B and pheophorbide (PHO) A and B were added to methyl linoleate (ML). The sample oils were then subjected to photooxidation at 0°C and the peroxide value and absorbance at 234 nm were measured. Chlorophylls catalyzed oxidation of methyl linoleate at concentrations greater than 2.2×10^{-9} mol/g ML, and CHL B showed a stronger prooxidant activity, ca. twice that of CHL A under the same light intensity. PHY and PHO exhibited stronger prooxidant activities than CHL, the prooxidant activity of PHO being the strongest among them. Moreover, photosensitive activity was found in PHY as well as in CHL. These results suggest that particular attention should be paid to the decomposition products of CHL that affect the quality of vegetable oils.

INTRODUCTION

Since Coe (1) reported that the content of chlorophyll (CHL) is closely correlated with the extent of deterioration of oils, many reports have suggested that CHL is a pro-

oxidant in fats and oils (2-5). CHL is known to act as a photosensitizer of oils, accompanying the generation of singlet oxygen when exposed to light (6-8). However, the prooxidant effects of CHL, especially the effect of its degradation products on the deterioration of oils, has never been systematically studied. In addition, what role the decomposition products of CHL play on the oxidative stabilities of oils has not been known.

The purpose of this study is to investigate the effects of magnesium chelated CHL and its degradation products, pheophytin (PHY) and pheophorbide (PHO), which are free of magnesium (Fig. 1), on the oxidative stability of oils, especially the prooxidant effects on methyl linoleate (ML).

MATERIAL AND METHODS

Materials

CHL A and B were prepared from acetone extracts of fresh spinach by DEAE-Sepharose CL-6B and Sepharose CL-6B (Pharmacia Fine Chemicals Piscataway, NJ) column